

RSIC-1-BACKER SOUND ISOLATION CLIP

RSIC-1-BACKER INSTALLATION GUIDE

RSIC-1 BACKER RSIC-1 BACKER HD/DD

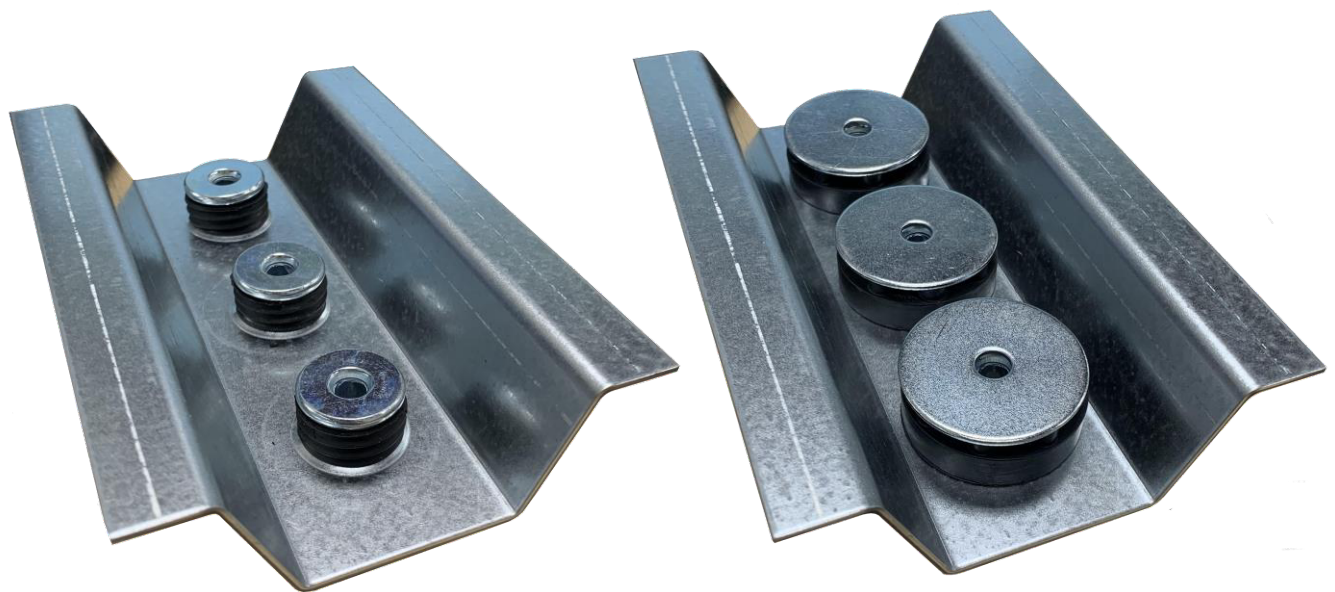

For use in with the RSIC-1 clip

PAC International, LLC. All Rights Reserved.

RSIC® is a registered Trade Mark

Distributed by SoundAway - Sales@SoundAway.com - (760) 599-3985

RSIC-1 BACKER SOUND ISOLATION CLIP

RSIC-1 BACKER INSTALLATION GUIDE

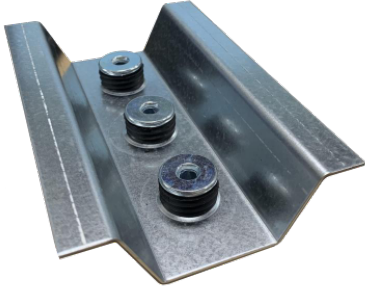

Resilient Sound Isolation Clip (RSIC-1 BACKER)

- Spacing: maximum 48 inches on center
- Maximum acoustical design load:
RSIC-1 BACKER 108 lbs
RSIC-1 BACKER HD/DD 216 lbs
- RSIC-1 BACKER is designed for use with the RSIC-1 clip to support heavy loads

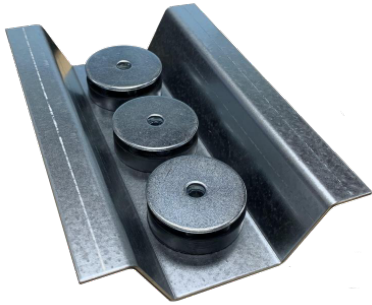

RSIC-1 BACKER dimensions:

- RSIC-1 BACKER clip 3" wide
- RSIC-1 BACKER clip 6" long
- RSIC-1 BACKER clip 1-5/8" deep

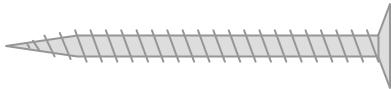

2-1/2" min

Fasteners:

- RSIC-1 BACKER to wood: #8 x 2-1/2 inch min.
- RSIC-1 BACKER HD/DD to wood: #10 or #12 x 2-1/2 inch min.
- RSIC-1 BACKER to Steel: # 8 x 1-5/8 inch min.
- RSIC-1 BACKER HD/DD to Steel: #10 or #12 x 1-5/8 inch min.
- Steel Track to RSIC-1 Backer: 1/2" min. pan head self drilling framing screw
- DO NOT fasten Resilient Sound Isolation Clips to framing members with nails. Use only approved screws.

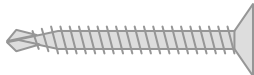

1-5/8" min

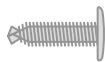

1/2" min

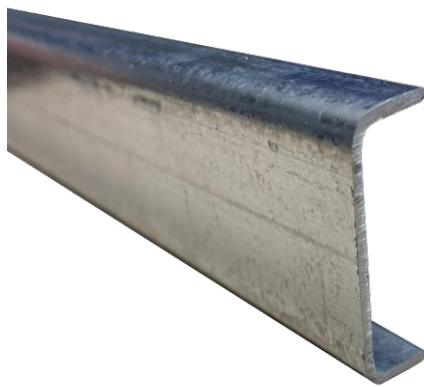

Steel Track:

- Minimum requirements: 16 gauge Steel Track. Meets or exceeds SSMA min. requirements.
- Depth: 1-1/4 inch
- Width 6 inch wide.

Average Labor Rates:

RSIC-1 BACKER: 40 clips per man hour

PAC International, LLC. All Rights Reserved.

RSIC® is a registered Trade Mark

Distributed by SoundAway - Sales@SoundAway.com - (760) 599-3985

RSIC-1 BACKER SOUND ISOLATION CLIP

RSIC-1 BACKER INSTALLATION GUIDE

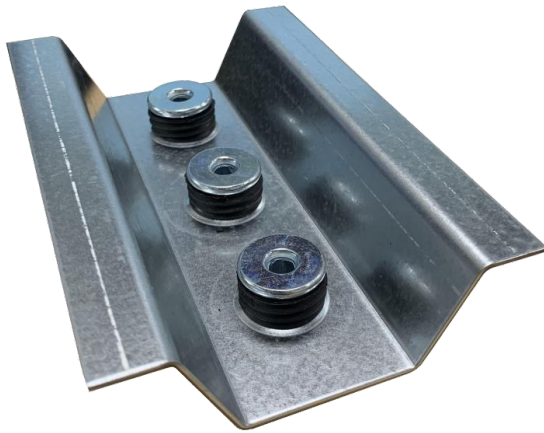

RSIC-1 BACKER

108 Lb per isolator max load

RSIC-1 BACKER Clip fastens to the wall framing adding support to the RSIC-1 clip wall system for supporting heavy loads.

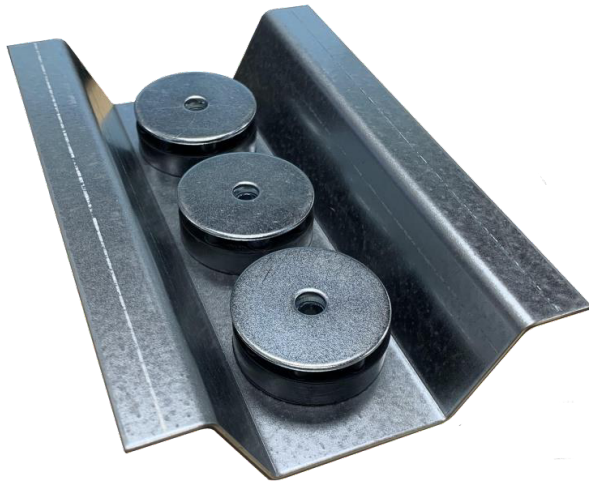

RSIC-1 BACKER HD/DD

216 Lbs per isolator max load

RSIC-1 BACKER HD/DD Clip fastens to the wall framing adding support to the RSIC-1 clip wall system for supporting heavy loads.

Walls:

- Resilient Sound Isolation Clip (RSIC-1 BACKER) shall be on every stud
- Spacing not to be greater than 48 inches on center.
- Locate the areas where the additional support will be needed in the wall system. Make a note on the plans referencing the location of each RSIC-1 BACKER and the steel track for mounting the additional items to the wall after the gypsum board is installed.
- Fasten the Resilient Sound Isolation Clip (RSIC-1 BACKER) to the framing using a fastener ensuring all of the RSIC-1 BACKER clips are in the same horizontal plane
- Fasten the steel track to the RSIC-1 BACKER using 4 ea framing screws per RSIC-1 BACKER.

PAC International, LLC. All Rights Reserved.

RSIC® is a registered Trade Mark

Distributed by SoundAway - Sales@SoundAway.com - (760) 599-3985

RSIC-1 BACKER SOUND ISOLATION CLIP

RSIC-1 BACKER INSTALLATION GUIDE

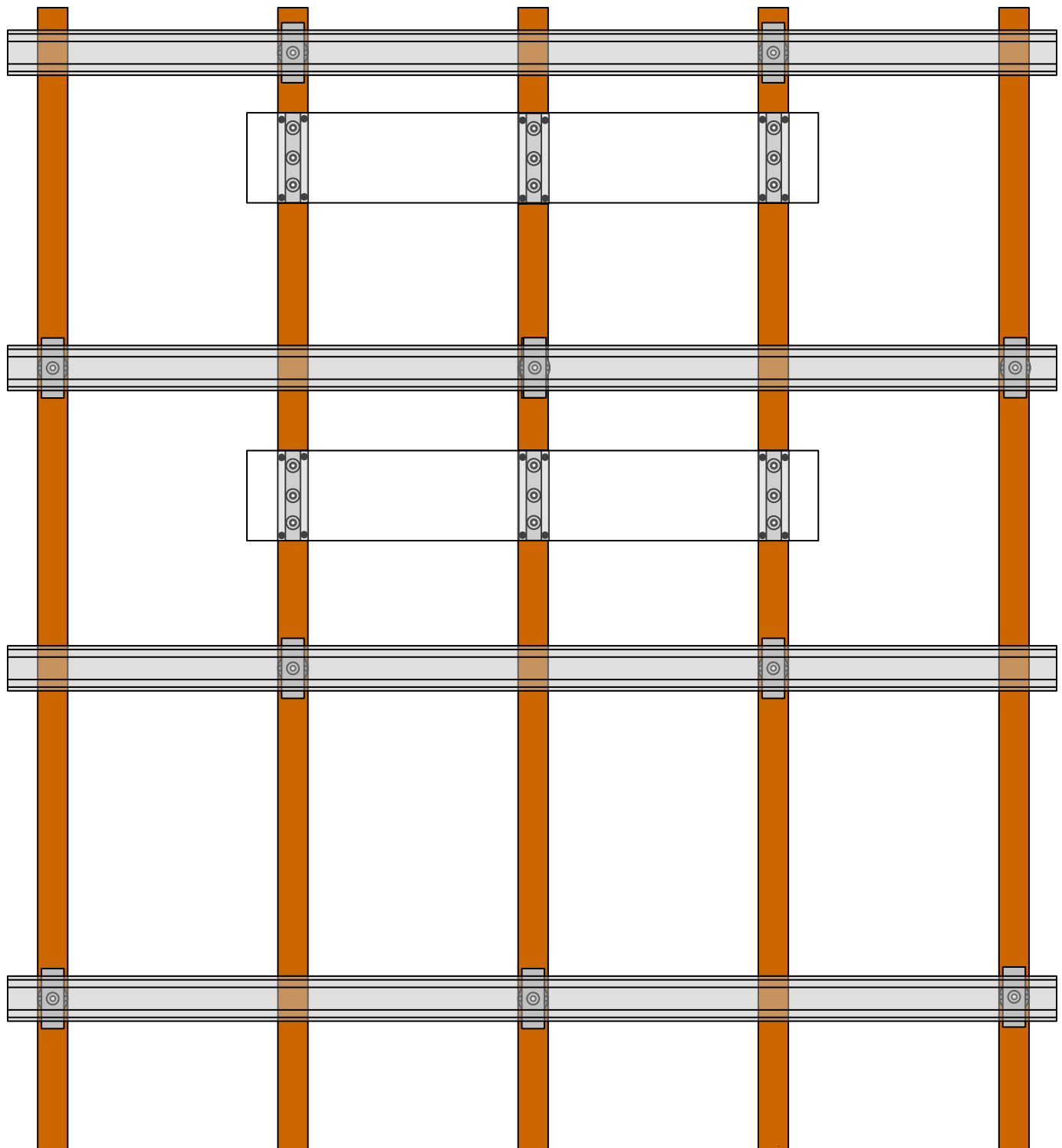

PAC International, LLC. All Rights Reserved.

RSIC® is a registered Trade Mark

Distributed by SoundAway - Sales@SoundAway.com - (760) 599-3985

RSIC-1 BACKER SOUND ISOLATION CLIP

RSIC-1 BACKER INSTALLATION GUIDE

A3 RSIC-1-BACKING BASE (RSIC-1-BB)

SCALE: As indicated

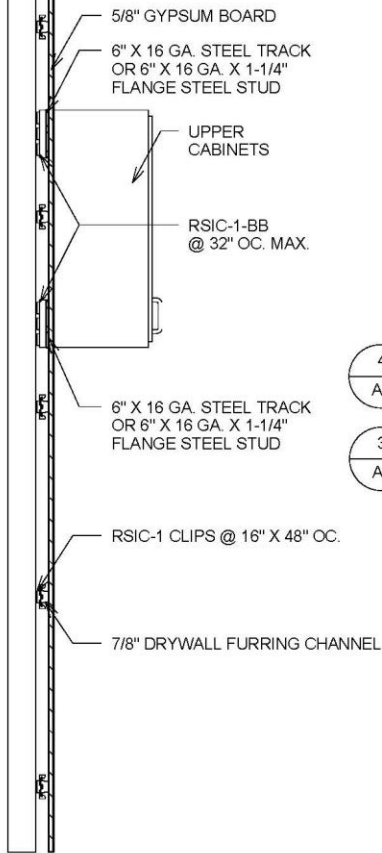

① WALL SECTION
3/4" = 1'-0"

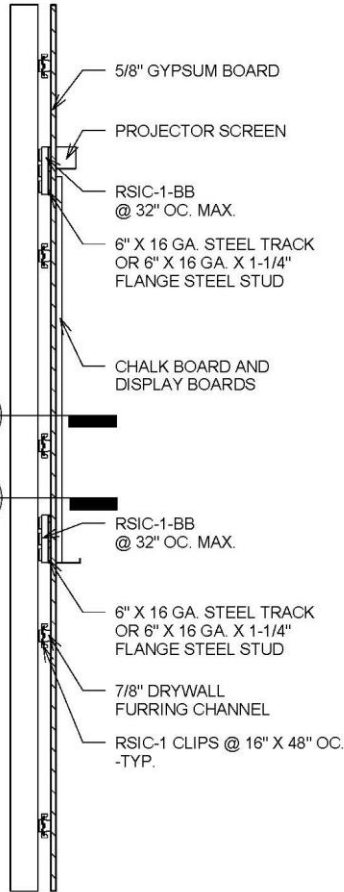

② WALL SECTION
3/4" = 1'-0"

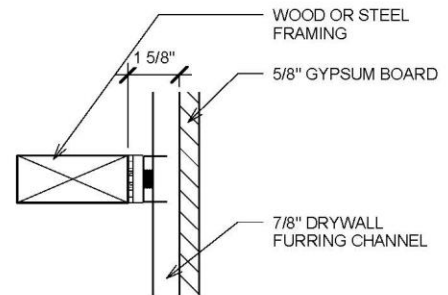
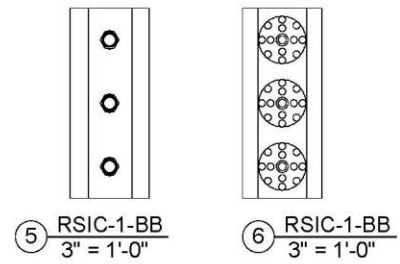

④ ENLARGED DETAIL
3" = 1'-0"

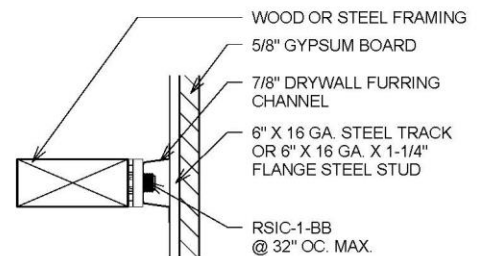

③ ENLARGED DETAIL
3" = 1'-0"

RSIC-1 BACKER SOUND ISOLATION CLIP

RSIC-1 BACKER INSTALLATION GUIDE

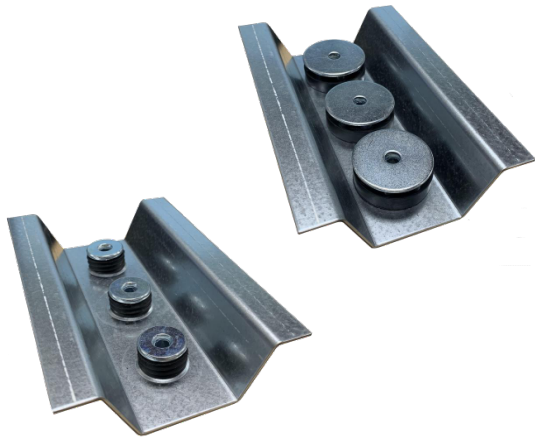

Members of the International
Code Council

WARRANTY DISCLAIMER AND LIABILITY LIMITATION LANGUAGE

NO EXPRESS OR IMPLIED WARRANTIES

THERE IS NO WARRANTY, REPRESENTATION OR CONDITION OF ANY KIND; AND ANY WARRANTY, EXPRESS OR IMPLIED, IS EXCLUDED AND DISCLAIMED, INCLUDING THE IMPLIED WARRANTIES OF MERCHANTABILITY AND OF FITNESS FOR A PARTICULAR PURPOSE. Some states do not allow limitations on implied warranties, so the above limitation may not apply to you.

LIABILITY LIMITED TO RETURN OF PURCHASE PRICE

IT IS AGREED THAT SELLER'S LIABILITY AND PURCHASER'S SOLE REMEDY, WHETHER IN CONTRACT, UNDER ANY WARRANTY, IN TORT (INCLUDING NEGLIGENCE), IN STRICT LIABILITY OR OTHERWISE, SHALL NOT EXCEED THE RETURN OF THE AMOUNT OF THE PURCHASE PRICE PAID BY PURCHASER, AND UNDER NO CIRCUMSTANCES SHALL SELLER BE LIABLE FOR ANY SPECIAL, INCIDENTAL OR CONSEQUENTIAL DAMAGES, INCLUDING, BUT NOT LIMITED TO, PERSONAL INJURY, PROPERTY DAMAGE, DAMAGE TO OR LOSS OF EQUIPMENT, LOST PROFITS OR REVENUE, COSTS OF RENTING REPLACEMENTS AND OTHER ADDITIONAL EXPENSES, EVEN IF SELLER HAS BEEN ADVISED OF THE POSSIBILITY OF SUCH DAMAGES. THE PRICE STATED FOR THE EQUIPMENT IS A CONSIDERATION IN LIMITING SELLER'S LIABILITY AND PURCHASER'S REMEDY. Some states do not allow the exclusion or limitation of incidental or consequential damages, so the above limitation or exclusion may not apply to you.

SELLER NOT LIABLE FOR PURCHASER'S NEGLIGENCE

SELLER WILL NOT BE LIABLE FOR ANY DAMAGES, LOSSES OR EXPENSES AS A RESULT OF PURCHASER'S NEGLIGENCE, WHETHER DEEMED ACTIVE OR PASSIVE AND WHETHER OR NOT ANY SUCH NEGLIGENCE IS THE SOLE CAUSE OF ANY SUCH DAMAGE, LOSS OR EXPENSE.

MODEL FOR DEMONSTRATION PURPOSES ONLY

THE MODEL OR SAMPLE SHOWN BY SELLER TO BUYER IS USED FOR DEMONSTRATION PURPOSES ONLY. THERE IS NO WARRANTY THAT THE GOODS AS DELIVERED SHALL CONFORM TO THE MODEL OR SAMPLE, AND CONFORMITY OF THE GOODS TO THE MODEL OR SAMPLE IS NOT PART OF THE BASIS OF THE BARGAIN BETWEEN SELLER AND BUYER.

NO WARRANTY OR COMPLIANCE WITH SAFETY CODE OR REGULATION

SELLER DOES NOT WARRANT THAT ANY OF THE GOODS SOLD WILL MEET OR COMPLY WITH THE REQUIREMENTS OF ANY SAFETY CODE, BUILDING OR DWELLING CODE, OR REGULATION OF ANY STATE, MUNICIPALITY OR OTHER JURISDICTION.

NEVADA LAW APPLIES

SELLER AND BUYER AGREE THAT ALL ASPECTS OF THIS TRANSACTION INCLUDING THE APPLICABLE STATUTE OF LIMITATIONS SHALL BE GOVERNED BY THE INTERNAL LAW OF THE STATE OF NEVADA, AND NOT THE LAWS OF CONFLICTS.

This warranty gives you specific legal rights, and you may also have other rights which vary from state to state

PAC International, LLC. All Rights Reserved.

RSIC® is a registered Trade Mark

Distributed by SoundAway - Sales@SoundAway.com - (760) 599-3985